

Han PE-module male crimp 16qmm

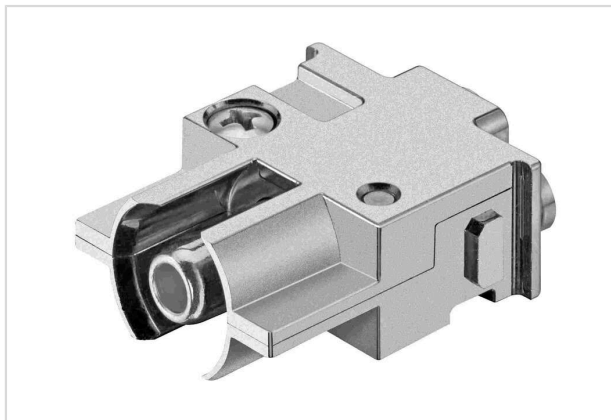

Image is for illustration purposes only. Please refer to product description.

Part number	09 14 001 3072
Specification	Han PE-module male crimp 16qmm
HARTING eCatalogue	https://b2b.harting.com/09140013072

Identification

Category	Modules
Series	Han-Modular®
Type of module	Han® PE module
Size of the module	Single module

Version

Termination method	Crimp termination
Gender	Male
Number of contacts	1
Pack contents	2 PE module halves 1 contact pressure plate 1 crimp contact

Technical characteristics

Conductor cross-section	16 mm ²
Contact resistance	≤0.3 mΩ
Stripping length	19 mm
Tightening torque	2 Nm
Limiting temperature	-40 ... +125 °C
Mating cycles	≥500

Material properties

Material (insert)	Zinc die-cast, nickel-plated
-------------------	------------------------------



Pushing Performance
Since 1945

Material properties

Material (contacts)	Copper alloy
Surface (contacts)	Silver plated
RoHS	compliant with exemption
RoHS exemptions	6(c): Copper alloy containing up to 4 % lead by weight
ELV status	compliant with exemption
China RoHS	50
REACH Annex XVII substances	Not contained
REACH ANNEX XIV substances	Not contained
REACH SVHC substances	Yes
REACH SVHC substances	Lead
ECHA SCIP number	5dbb3851-b94e-4e88-97a1-571845975242
California Proposition 65 substances	Yes
California Proposition 65 substances	Lead Nickel

Specifications and approvals

Specifications	IEC 61984
UL / CSA	UL 1977 ECBT2.E235076 CSA-C22.2 No. 182.3 ECBT8.E235076

Commercial data

Packaging size	1
Net weight	75.8 g
Country of origin	Germany
European customs tariff number	85366990
GTIN	5713140184893
eCl@ss	27440217 Module for industrial connectors (power/signals)